

ASSEMBLY INSTRUCTIONS

TESTED TO



WIDE SPAN (MULTIPLE PACKAGES)

COMPONENTS

- A** Uprights frames
2 of:
2000mm, 2500mm
or 3000mm W
600mm or 900mm D

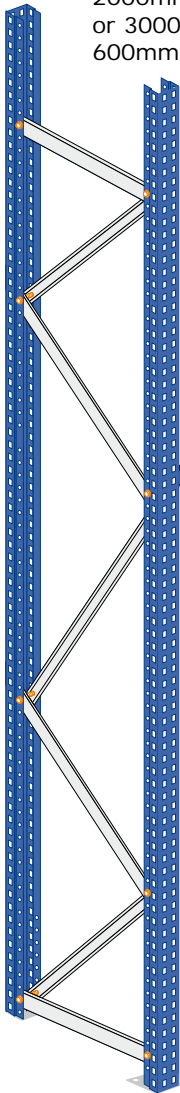

- B** Floor fixing, 2 per frame



- C** Front and rear beams

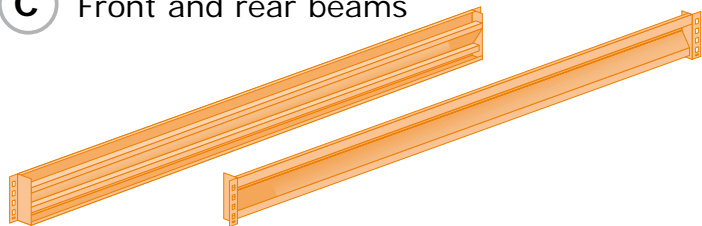

- D** Chipboard shelves
1 per shelf level, width and depth to suit

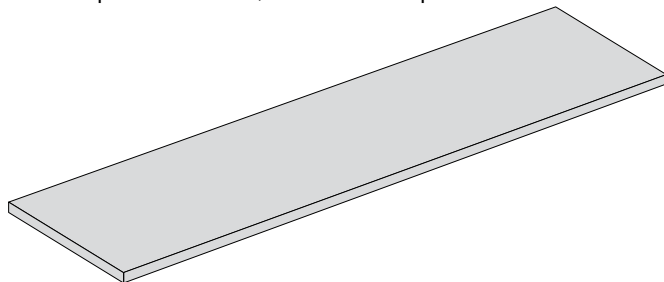

- E** Shelf supports
- Not required for 890mm or 1250mm widths
 - 600 mm deep bay: 2 per level
 - Other depths 3 per level

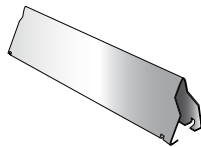

- F** Beam safety clips
2 per beam - 4 per level

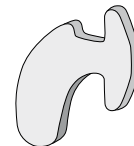

SAFETY

<p>Keep heavier items on the bottom shelves.</p>		<p>Keep your shelving dry.</p>	<p>Do not climb on your shelving.</p>	<p>Make sure it is on a level and even floor.</p>

ASSEMBLY - MULTIPLE SIZES

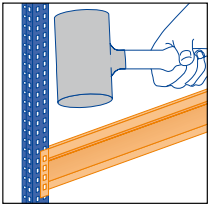

Safety advice: We advise you wear protective gloves when assembling this product.
Tools required: Rubber mallet, electric drill and metric spanners.

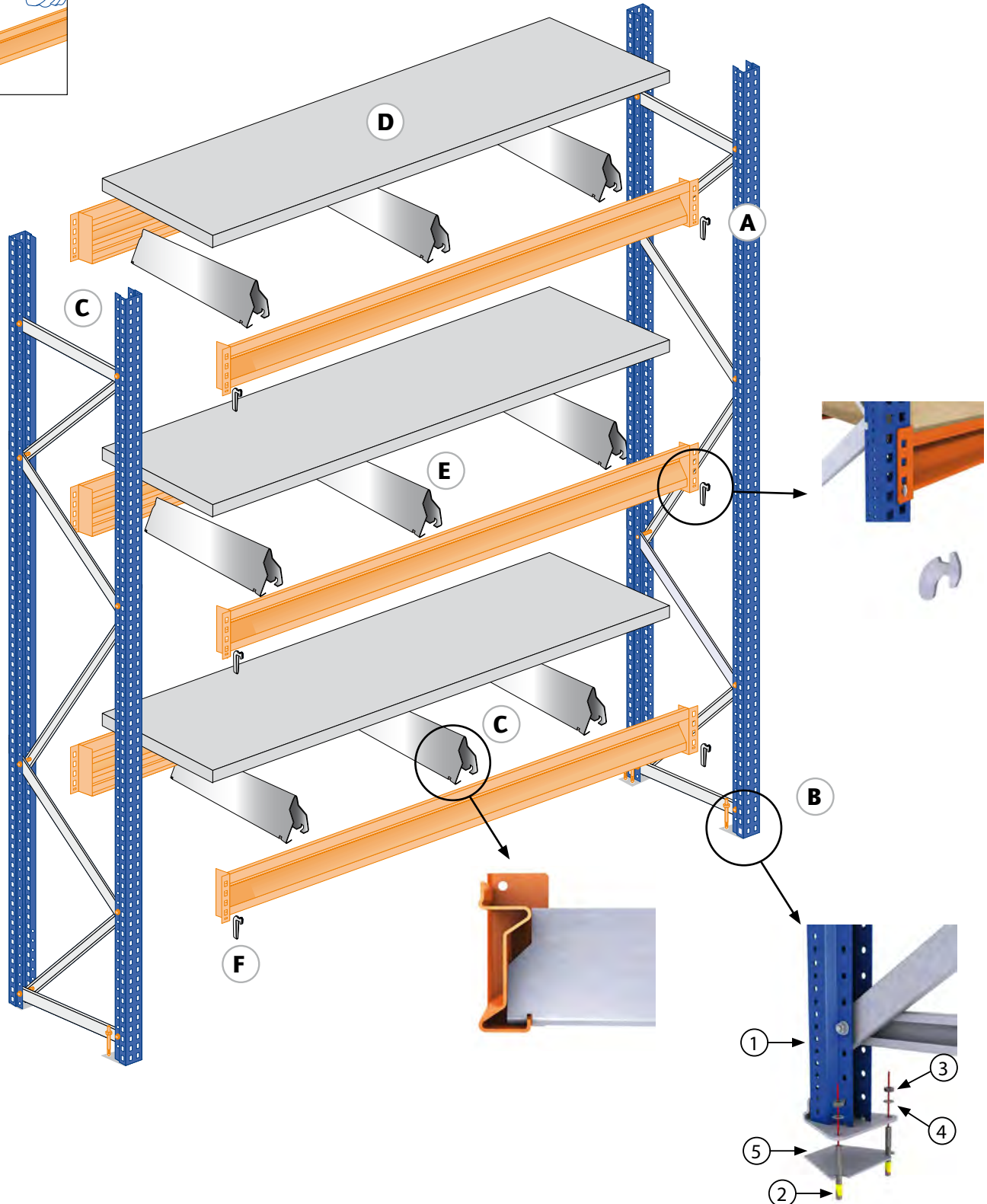

1. Join the upright frames using front and rear beams **C**, at the desired level.
2. Insert the beam safety clips **F**.
3. Add shelf supports **E** where required, and evenly space.
4. Place shelves **D** onto front and rear beams **C**.
5. Secure the unit to the floor with the fixings **B**.

NB: This shelving system is not designed to be loaded by mechanical means, e.g. fork lift truck.
Always load and unload by hand.

Posts (1) can be levelled vertically with shims (5) if necessary.
Floor fixing with sleeve anchors (2) is required for bays 2.5m high or over.